

BH SERIES-PGI 1-0386

EAN 8422202103860



Injected grey rubber castors. Especially indicated to support loads up to 60kg (132lb).

It is used in: supermarkets, display stands, furniture, stackable boxes, stools, display cabinets, clothes racks, catering carts, hospital equipment, clinical furniture and drips.

PGI: does not scratch or leave marks on floor. Noiseless.

Technical Data

Housing Type	Swivel
Fitting Type	Plate
Braking System	Wheel Brake And Fork
Material	Rubber
Bearing	Plain
Diameter (mm)	80
Width of tyre (mm)	22
Plate dimensions (mm)	70x55
Distance between holes (mm)	54x38
Plate hole diameter (mm)	6
Offset (mm)	77
Overall height (mm)	112
Load	60
Unit Weight of the wheel (kg)	0.48
Volume (cm ³)	850

CAD

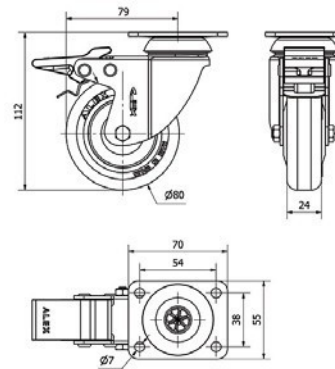

To visualize the image with higher resolution and more technical details, please access to the CAD section

Brackets

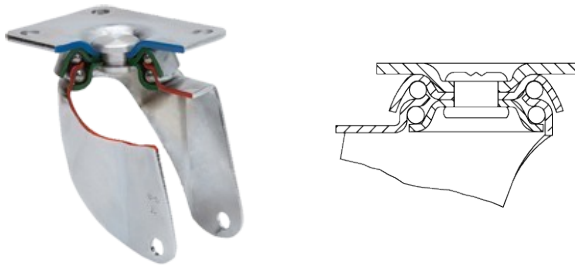

Made of pressed steel up to 2 mm. Finish: zinc-plated. Double ball bearing swivel head. Manufactured to European standards EN 12530.

Similar products



1-0180



2-2459

Wheel



Grey rubber tyre on polypropylene centre
Temperature range: -20° ÷ +60°

