

ZVI SERIES-UT 2-1167

EAN 8422202211671



White polypropylene castors with stainless steel (AISI 304) components. Especially indicated to support high-loads up to 350kg (772lb).

It is used in: outdoor areas, food trolleys, canteens, dining rooms, restaurants, food industry, logistics for military missions material, packaging machines, conveyor belts, stainless steel constructions, light machinery for the construction, containers, roll containers, transport cages, poultry farms, chemical industry, bakery machines, food chains, fridges, freezer cabinets and freezers.

Suitable for mechanical engineering projects by craftsmen and project executors.

UT: undeformable and resistant. Easy to start and move.

Technical Data

Housing Type	Fixed
Fitting Type	Plate
Braking System	Without Brake
Material	Polypropylene
Bearing	Plain
Diameter (mm)	150
Width of tyre (mm)	45
Plate dimensions (mm)	136x116
Distance between holes (mm)	105x80
Plate hole diameter (mm)	10
Overall height (mm)	196
Load	350
Unit Weight of the wheel (kg)	1.36
Volume (cm ³)	3410

CAD

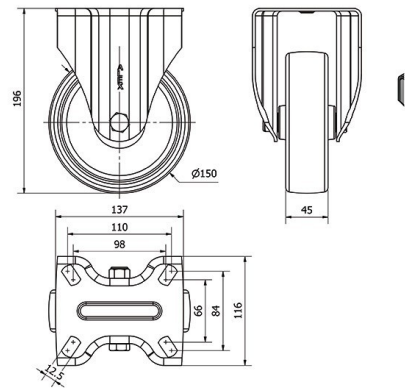

To visualize the image with higher resolution and more technical details, please access to the CAD section

Brackets

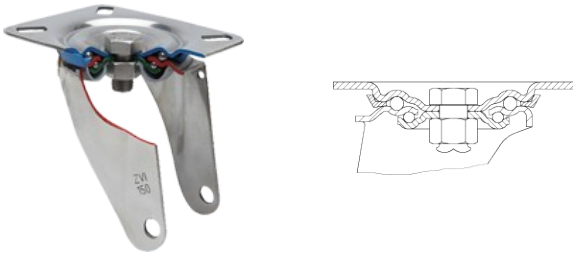

Made of high-quality pressed stainless steel (AISI 304) up to 3 mm. Bracket made completely of stainless steel, corrosion-free, resistant to petrol, diesel, oils and grease. Manufactured to European standards EN 12530/12532.

Similar products



Wheel



White Polypropylene wheel

Temperature range: -20° ÷ +60°

Rolling Resistance Very Good



Noise during the march Reasonable



Floor Protection Reasonable

