

TV SERIES-PO 2-1615

EAN 8422202216157



Castors with white nylon centre and red polyurethane tyre with a hardness of 90°-95° Shore A. Especially indicated to support high-loads up to 300kg (661lb).

It is used in: logistics transport tools, outdoor areas, tool trolleys, internal logistics, tubular carts, pneumatic factories, mobile platforms, transport tools, elevating platforms, food industry, transport carts, repair shops, logistics for military missions material, tool transport, ladders, sweeping machines, polishing machines, packaging machines, conveyor belts and heavy machinery.

Mainly used in the aeronautic sector, railway and automobile factories and food industry.

Suitable for mechanical engineering projects by draftsmen and project executors.

PO: noiseless. High floor protection. Long useful life. Resistant to oils, grease and shavings.

Technical Data

Housing Type	Swivel
Fitting Type	Plate
Braking System	Wheel Brake And Fork
Material	Polyurethane
Hardness of tread	90-95° SHORE A
Bearing	Ball
Diameter (mm)	125
Width of tyre (mm)	42
Plate dimensions (mm)	139x110
Distance between holes (mm)	105x80
Plate hole diameter (mm)	10
Offset (mm)	115
Overall height (mm)	164
Load	300
Unit Weight of the wheel (kg)	2.45
Volume (cm ³)	4095

CAD

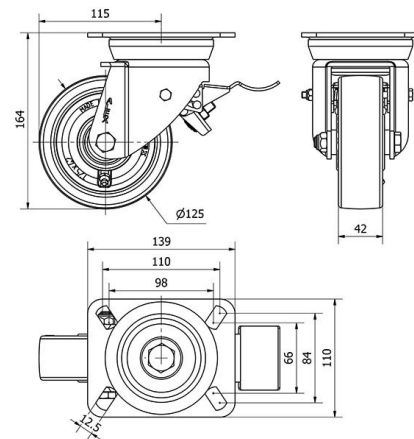

To visualize the image with higher resolution and more technical details, please access to the CAD section

Brackets



Manufactured with pressed steel up to 5 mm. Highly rust-resistant double-chrome coating. Double ball bearing reinforced with hardened ball races. Dust-proof in the sealing swivel head. Manufactured to European standard EN 12532.

Similar products



2-0313



2-0314

Wheel



Red polyurethane tyre on white polyamide centre.95° shore A
Temperature range: -25° ÷ +80°

Rolling Resistance	Very Good
Noise during the march	Very Good
Floor Protection	Very Good