

## TV SERIES-HU 2-2056

EAN 8422202220567



Castors with steel centre and cast polyurethane tyre with a hardness of 95° Shore A, especially indicated to support high-loads up to 400kg (882lb).

It is used in: logistics transport tools, outdoor areas, carbody factories, internal logistics, mobile platforms, elevating platforms, containers, logistics for military missions material, mobile cranes, elevating tables, carts, equipments and industrial areas

Suitable for mechanical engineering projects by draftsmen and project executors.

HU: heavy duty. High absorption to impacts. Unfavourable flooring surfaces conditions. Rough surfaces, broken, with metallic shavings, oil stains, glasses, grease and gravel.

### Technical Data

Housing Type	<b>Fixed</b>
Fitting Type	<b>Plate</b>
Braking System	<b>Without Brake</b>
Material	<b>Polyurethane</b>
Hardness of tread	<b>95° SHORE A</b>
Bearing	<b>Ball</b>
Diameter (mm)	<b>125</b>
Width of tyre (mm)	<b>40</b>
Plate dimensions (mm)	<b>136x116</b>
Distance between holes (mm)	<b>105x80</b>
Plate hole diameter (mm)	<b>10</b>
Overall height (mm)	<b>164</b>
Load	<b>400</b>
Unit Weight of the wheel (kg)	<b>2.56</b>
Volume (cm <sup>3</sup> )	<b>2644</b>

### CAD

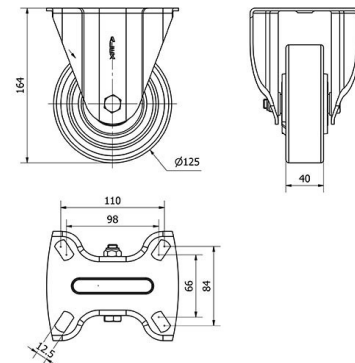

To visualize the image with higher resolution and more technical details, please access to the CAD section

## Brackets

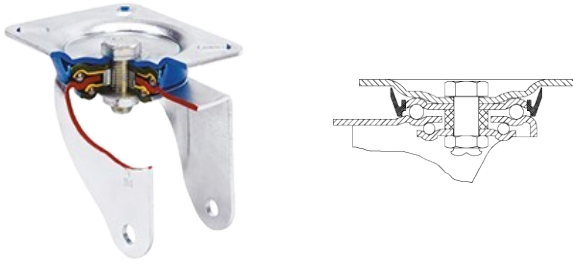

Manufactured with pressed steel up to 5 mm. Highly rust-resistant double-chrome coating. Double ball bearing reinforced with hardened ball races. Dust-proof in the sealing swivel head. Manufactured to European standard EN 12532.

## Similar products



2-2055



2-2057

## Wheel



Rolling Resistance Very Good



Noise during the march Good



Floor Protection Very Good

