

ZV SERIES-POL 2-2354

EAN 8422202223544



Castors with white polypropylene centre and brown cast polyurethane tyre with a hardness of 95° Shore A. Especially indicated to support high-loads up to 100kg (221lb).

It is used in: logistics transport tools, repair shops, outdoor areas, internal logistics, tool trolleys, tubular carts, pneumatic factories, internal logistics, transport tools, elevating platforms, transport carts, ladders, sweeping machines, polishing machines, packaging machines, conveyor belts, mobile cranes, elevating driven carts, boilers, cabinetmaker's, metalworks, agricultural farms, elevating tables, meat industry, containers, sport centres and sound boxes.

Mainly used in the aeronautic sector, railway, automobile factories, food industry, repair shops and industrial activities.

Suitable for mechanical engineering projects by draftsmen and project executors.

POL: long useful life. High resistance to oils and grease. Noiseless, clean and undeformable.

Technical Data

Housing Type	Swivel
Fitting Type	Plate
Braking System	Without Brake
Material	Polyurethane
Hardness of tread	95° SHORE A
Bearing	Plain
Diameter (mm)	80
Width of tyre (mm)	32
Plate dimensions (mm)	105x80
Distance between holes (mm)	86/80x60
Plate hole diameter (mm)	8
Offset (mm)	77
Overall height (mm)	110
Load	100
Unit Weight of the wheel (kg)	0.58
Volume (cm ³)	1140

CAD

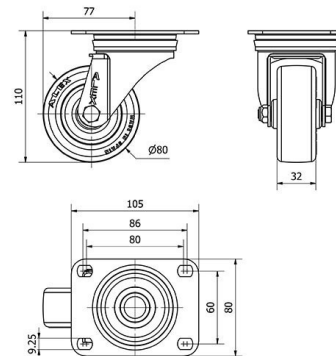

To visualize the image with higher resolution and more technical details, please access to the CAD section

Brackets

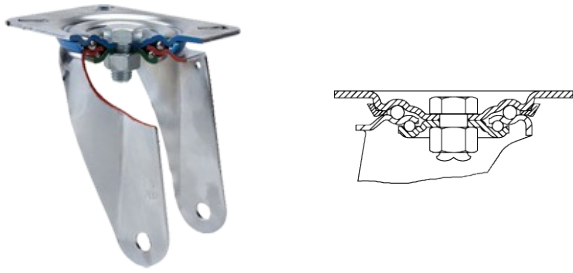

Made of pressed steel up to 4 mm. Finish: zinc plated finish. Double ball bearing in the swivel head. Universal model for medium-duty loads. Manufactured to European standards EN 12530/12532.

Similar products



2-2360



2-2366

Wheel



Brown polyurethane tyre on white polypropylene centre. 90° shore A

Temperature range: -25° ÷ +80°

Rolling Resistance Very Good

Noise during the march Very Good

Floor Protection Very Good