

ZV SERIES-POL 2-2359

EAN 8422202223599



Castors with white polypropylene centre and brown cast polyurethane tyre with a hardness of 95° Shore A. Especially indicated to support high-loads up to 300kg (661lb).

It is used in: logistics transport tools, repair shops, outdoor areas, internal logistics, tool trolleys, tubular carts, pneumatic factories, internal logistics, transport tools, elevating platforms, transport carts, ladders, sweeping machines, polishing machines, packaging machines, conveyor belts, mobile cranes, elevating driven carts, boilers, cabinetmaker's, metalworks, agricultural farms, elevating tables, meat industry, containers, sport centres and sound boxes.

Mainly used in the aeronautic sector, railway, automobile factories, food industry, repair shops and industrial activities.

Suitable for mechanical engineering projects by draftsmen and project executors.

POL: long useful life. High resistance to oils and grease. Noiseless, clean and undeformable.

Technical Data

Housing Type	Swivel
Fitting Type	Plate
Braking System	Without Brake
Material	Polyurethane
Hardness of tread	95° SHORE A
Bearing	Plain
Diameter (mm)	200
Width of tyre (mm)	50
Plate dimensions (mm)	140x110
Distance between holes (mm)	105x80
Plate hole diameter (mm)	10
Offset (mm)	153
Overall height (mm)	242
Load	300
Unit Weight of the wheel (kg)	2.39
Volume (cm ³)	5936

CAD

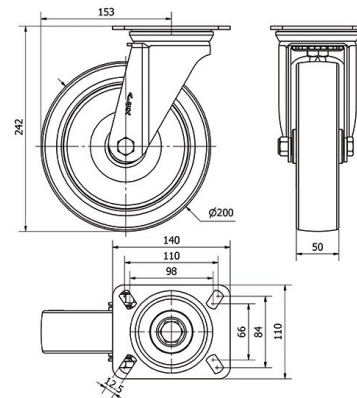

To visualize the image with higher resolution and more technical details, please access to the CAD section

Brackets

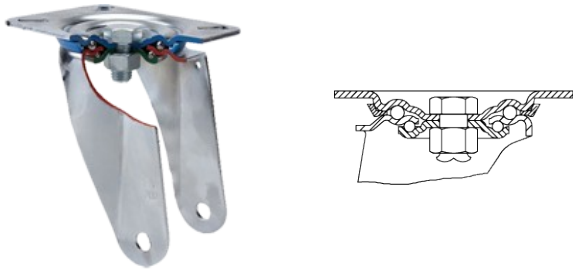

Made of pressed steel up to 4 mm. Finish: zinc plated finish. Double ball bearing in the swivel head. Universal model for medium-duty loads. Manufactured to European standards EN 12530/12532.

Similar products



2-2365



2-2371



2-3341

Wheel



Brown polyurethane tyre on white polypropylene centre. 90° shore A

Temperature range: -25° ÷ +80°

Rolling Resistance Very Good



Noise during the march Very Good



Floor Protection Very Good

