

ZVI SERIES-UT 2-2414

EAN 8422202224145



White polypropylene castors with stainless steel (AISI 304) components. Especially indicated to support high-loads up to 130kg (287lb).

It is used in: outdoor areas, food trolleys, canteens, dining rooms, restaurants, food industry, logistics for military missions material, packaging machines, conveyor belts, stainless steel constructions, light machinery for the construction, containers, roll containers, transport cages, poultry farms, chemical industry, bakery machines, food chains, fridges, freezer cabinets and freezers.

Suitable for mechanical engineering projects by craftsmen and project executors.

UT: undeformable and resistant. Easy to start and move.

Technical Data

Housing Type	Swivel
Fitting Type	Plate
Braking System	Wheel Brake And Fork
Material	Polypropylene
Bearing	Plain
Diameter (mm)	80
Width of tyre (mm)	34
Plate dimensions (mm)	105x80
Distance between holes (mm)	86/80x60
Plate hole diameter (mm)	8
Offset (mm)	77
Overall height (mm)	110
Load	130
Unit Weight of the wheel (kg)	0.57
Volume (cm ³)	1509

CAD

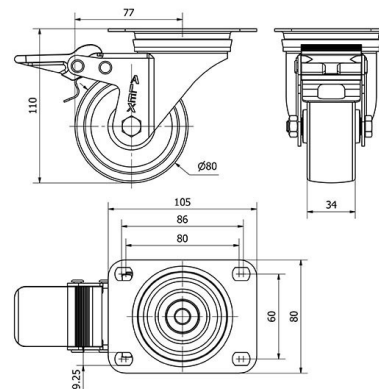

To visualize the image with higher resolution and more technical details, please access to the CAD section

Brackets

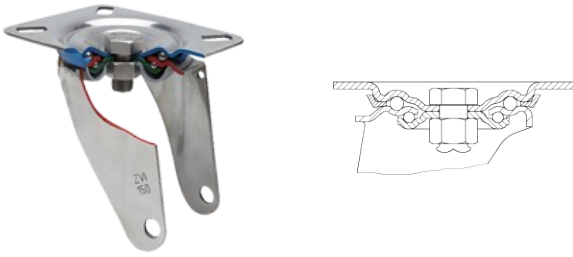

Made of high-quality pressed stainless steel (AISI 304) up to 3 mm. Bracket made completely of stainless steel, corrosion-free, resistant to petrol, diesel, oils and grease. Manufactured to European standards EN 12530/12532.

Similar products



Wheel



White Polypropylene wheel

Temperature range: -20° ÷ +60°

Rolling Resistance Very Good



Noise during the march Reasonable



Floor Protection Reasonable

