

ZVI SERIES-POL 2-2422

EAN 8422202224220



Injected polyurethane castors with stainless steel (AISI 304) components. Especially indicated to support high-loads up to 100kg (221lb).

It is used in: outdoor areas, food trolleys, canteens, dining rooms, restaurants, food industry, logistics for military missions material, packaging machines, conveyor belts, stainless steel constructions, light machinery for the construction, containers, roll containers, transport cages, poultry farms, chemical industry, food chains, fridges, freezer cabinets and freezers.

Suitable for mechanical engineering projects by craftsmen and project executors.

POL: long useful life. High resistance to oils and grease. Noiseless, clean and undeformable.

Technical Data

Housing Type	Fixed
Fitting Type	Plate
Braking System	Without Brake
Material	Polyurethane
Hardness of tread	95° SHORE A
Bearing	Plain
Diameter (mm)	80
Width of tyre (mm)	32
Plate dimensions (mm)	107x86
Distance between holes (mm)	80x60
Plate hole diameter (mm)	8
Overall height (mm)	110
Load	100
Unit Weight of the wheel (kg)	0.435
Volume (cm ³)	1012

CAD

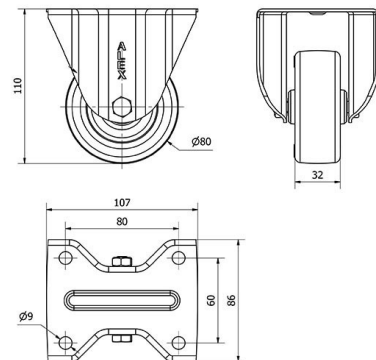

To visualize the image with higher resolution and more technical details, please access to the CAD section

Brackets

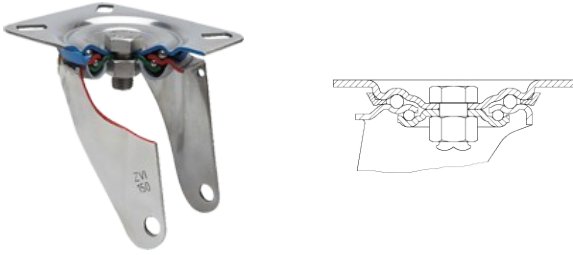

Made of high-quality pressed stainless steel (AISI 304) up to 3 mm. Bracket made completely of stainless steel, corrosion-free, resistant to petrol, diesel, oils and grease. Manufactured to European standards EN 12530/12532.

Similar products



Wheel



Brown polyurethane tyre on white polypropylene centre. 90° shore A

Temperature range: -25° ÷ +80°

Rolling Resistance	Very Good
Noise during the march	Very Good
Floor Protection	Very Good